

M12 male 0° / M12 female 0°

PVC 12x0.14 bk 25m

Male straight – female straight

M12 – M12, 12-pole

Art-No. 7005 - M12 Lite - (plastic hexagonal screw) on request

Plastic housings with good resistance against chemicals and oils.

The resistance to aggressive media should be individually tested for your application. Further details on request.

Further cable lengths on request.

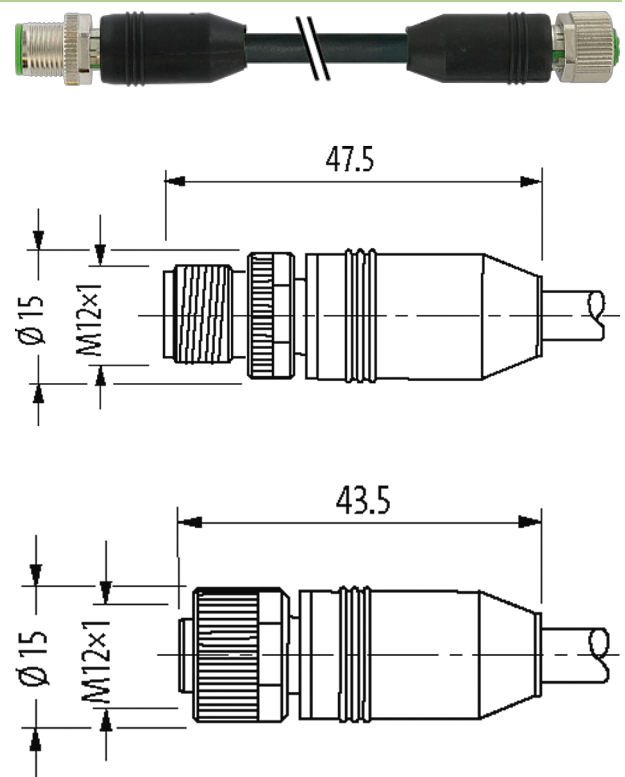
Link to Product**Illustration**

Product may differ from Image

Approvals

cCSAus

* only for products with UL/GSA approved cable

Form

Form 53001

General data

Standards	DIN EN 61076-2-101 (M12)
Temperature range	-25...+85 °C, depending on cable quality

Cables

No./diameter of wires	12× 0.14 mm ²
Wire isolation	PVC (br, bl, wh, gn, pk, ye, bk, gr, rd, vi, grpk, rdbl)
Material (jacket)	PVC

Outer Ø	6.0 mm ±5%
Bend radius (moving)	10× outer Ø
Temperature range (fixed)	-30...+70 °C
Temperature range (mobile)	-5...+70 °C
Cable identification	702
Cable Type	1 (PVC)
Approval (cable)	CE conform
Cable weight [g/m]	55,00
Material (wire)	Cu wire, bare
Resistor (core)	max. 138 Ω/km (20 °C)
Single wire Ø (core)	0.1 mm
Construction (core)	18× 0.1 mm (multi-strand wire class 6)
Diameter (core)	12× 0.14 mm ²
AWG	similar to AWG 26
Material (wire isolation)	PVC
Material property (wire isolation)	CFC-, cadmium-, silicone- and lead-free
Shore hardness (wire isolation)	85 ±5 A
Wire-Ø incl. isolation	1.0 mm ±5%
Color/numbering of wires	br, rd, gr, bk, ye, pk, gn, wh, bl, rdbl, grpk, vi
Stranding combination	Twisted wires rdbl, grpk and vi, over it all other wires are twisted
Shield	no
Material (jacket)	PVC
Material property (jacket)	CFC-, cadmium-, silicone- and lead-free, matt, low-adhesion, machine easy to process, abrasion-resistant
Shore hardness (jacket)	75 ±5 A
Outer-Ø (jacket)	6.0 mm ±5%
Color (jacket)	black
chemical resistance	good resistance to oil, gasoline and chemicals
Nominal voltage	300 V
Test voltage	1500 V AC
Temperature range (fixed)	-30...+70 °C
Temperature range (mobile)	-5...+70 °C
Bend radius (moving)	10× outer Ø
Jacket Color	black

Technical Data

Operating voltage	max. 30 V AC/DC
Rated surge voltage	0.8 kV
Operating current per contact	max. 1.5 A
Locking of ports	Screw thread (M12×1 mm) recommended torque 0.6 Nm, self-securing
Compression gland	M12 (SW13)
Protection	IP65, IP66K, IP67 inserted and tightened (EN 60529)
Locking material	Zinc die casting, matte nickel plated

Commercial data

country of origin	DE
customs tariff number	85444290
EAN	4048879723770
eClass	27279218
Packaging unit	1

Sketch

1	■	brown	⌋	1
2	■	blue	⌋	2
3	■	white	⌋	3
4	■	green	⌋	4
5	■	pink	⌋	5
6	■	yellow	⌋	6
7	■	black	⌋	7
8	■	gray	⌋	8
9	■	red	⌋	9
10	■	violet	⌋	10
11	■	gray/pink	⌋	11
12	■	red/blue	⌋	12

Male

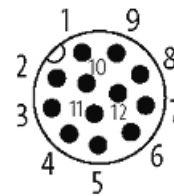

Female

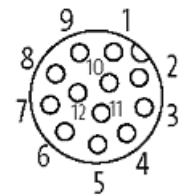

Product may differ from Image